



## Practice Test 2

## PHYSICS C

Physics C has two exams: Physics C (Mechanics) and Physics C (Electricity & Magnetism):

	<u>Physics C (Mechanics)</u>	<u>Physics C (Electricity &amp; Magnetism)</u>
First 45 min.	Sec. I, Multiple Choice 35 questions	Sec. I, Multiple Choice 35 questions
Second 45 min.	Sec. II, Free Response 3 questions	Sec. II, Free Response 3 questions

You may take just Mechanics or just Electricity and Magnetism, or both. If you take both, you will receive a separate grade for each. Each section of each examination is 50 percent of the total grade; each question in a section has equal weight. Calculators are permitted on both sections of the exam. However, calculators cannot be shared with other students and calculators with typewriter-style (QWERTY) keyboards will not be permitted. On the following pages you will find the Table of Information that is provided to you during the exam.

**If you are taking**

- *Mechanics only*, please be careful to answer numbers 1–35;
- *Electricity and Magnetism only*, please be careful to answer numbers 36–70;
- *the entire examination* (Mechanics and Electricity and Magnetism), answer numbers 1–70 on your answer sheet.

**GO ON TO THE NEXT PAGE.**

## ADVANCED PLACEMENT PHYSICS C TABLE OF INFORMATION

CONSTANTS AND CONVERSION FACTORS	
Proton mass, $m_p = 1.67 \times 10^{-27}$ kg Neutron mass, $m_n = 1.67 \times 10^{-27}$ kg Electron mass, $m_e = 9.11 \times 10^{-31}$ kg Avogadro's number, $N_0 = 6.02 \times 10^{23}$ mol <sup>-1</sup> Universal gas constant, $R = 8.31$ J/(mol K) Boltzmann's constant, $k_B = 1.38 \times 10^{-23}$ J/K	Electron charge magnitude, $e = 1.60 \times 10^{-19}$ C 1 electron volt, $1 \text{ eV} = 1.60 \times 10^{-19}$ J Speed of light, $c = 3.00 \times 10^8$ m/s Universal gravitational constant, $G = 6.67 \times 10^{-11}$ (N•m <sup>2</sup> )/kg <sup>2</sup> Acceleration due to gravity at Earth's surface, $g = 9.8$ m/s <sup>2</sup>
1 unified atomic mass unit, Planck's constant,  Vacuum permittivity, Coulomb's law constant, Vacuum permeability, Magnetic constant, 1 atmosphere pressure,	$1 \text{ u} = 1.66 \times 10^{-27}$ kg = 931 MeV/c <sup>2</sup> $h = 6.63 \times 10^{-34}$ J•s = 4.14 × 10 <sup>-15</sup> eV•s $hc = 1.99 \times 10^{-25}$ J•m = 1.24 × 10 <sup>3</sup> eV•nm $\epsilon_0 = 8.85 \times 10^{-12}$ C <sup>2</sup> /(N•m <sup>2</sup> ) $k = 1/(4\pi\epsilon_0) = 9.0 \times 10^9$ (N•m <sup>2</sup> )/C <sup>2</sup> $\mu_0 = 4\pi \times 10^{-7}$ (T•m)/A $k' = \mu_0/(4\pi) = 1 \times 10^{-7}$ (T•m)/A $1 \text{ atm} = 1.0 \times 10^5$ N/m <sup>2</sup> = 1.0 × 10 <sup>5</sup> Pa

UNIT SYMBOLS	meter, m	mole, mol	watt, W	farad, F
	kilogram, kg	hertz, Hz	coulomb, C	tesla, T
	second, s	newton, N	volt, V	degree Celsius, °C
	ampere, A	pascal, Pa	ohm, Ω	electron volt, eV
	kelvin, K	joule, J	henry, H	

VALUES OF TRIGONOMETRIC FUNCTIONS FOR COMMON ANGLES							
$\theta$	0°	30°	37°	45°	53°	60°	90°
$\sin\theta$	0	1/2	3/5	$\sqrt{2}/2$	4/5	$\sqrt{3}/2$	1
$\cos\theta$	1	$\sqrt{3}/2$	4/5	$\sqrt{2}/2$	3/5	1/2	0
$\tan\theta$	0	$\sqrt{3}/3$	3/4	1	4/3	$\sqrt{3}$	∞

PREFIXES		
Factor	Prefix	Symbol
10 <sup>9</sup>	giga	G
10 <sup>6</sup>	mega	M
10 <sup>3</sup>	kilo	k
10 <sup>-2</sup>	centi	c
10 <sup>-3</sup>	milli	m
10 <sup>-6</sup>	micro	μ
10 <sup>-9</sup>	nano	n
10 <sup>-12</sup>	pico	p

The following assumptions are used in this exam.

- I. The frame of reference of any problem is inertial unless otherwise stated.
- II. The direction of current is the direction in which positive charges would drift.
- III. The electric potential is zero at an infinite distance from an isolated point charge.
- IV. All batteries and meters are ideal unless otherwise stated.
- V. Edge effects for the electric field of a parallel plate capacitor are negligible unless otherwise stated.

GO ON TO THE NEXT PAGE.

MECHANICS		ELECTRICITY AND MAGNETISM	
$v_x = v_{x0} + a_x t$	$a = \text{acceleration}$	$ \vec{F}_E  = \frac{1}{4\pi\epsilon_0} \left  \frac{q_1 q_2}{r^2} \right $	$A = \text{area}$
$x = x_0 + v_{x0} t + \frac{1}{2} a_x t^2$	$E = \text{energy}$	$\vec{E} = \frac{\vec{F}_E}{q}$	$B = \text{magnetic field}$
$v_x^2 = v_{x0}^2 + 2a_x(x - x_0)$	$F = \text{force}$	$\oint \vec{E} \cdot d\vec{A} = \frac{Q}{\epsilon_0}$	$C = \text{capacitance}$
$\vec{a} = \frac{\Sigma \vec{F}}{m} = \frac{\vec{F}_{net}}{m}$	$f = \text{frequency}$	$E_x = -\frac{dV}{dx}$	$d = \text{distance}$
$\vec{F} = \frac{d\vec{p}}{dt}$	$h = \text{height}$	$\Delta V = -\int \vec{E} \cdot d\vec{r}$	$E = \text{electric field}$
$\vec{J} = \int \vec{F} dt = \Delta \vec{p}$	$I = \text{rotational inertia}$	$V = \frac{1}{4\pi\epsilon_0} \sum_i \frac{q_i}{r_i}$	$\epsilon = \text{emf}$
$\vec{p} = m\vec{v}$	$J = \text{impulse}$	$U_E = qV = \frac{1}{4\pi\epsilon_0} \frac{q_1 q_2}{r}$	$F = \text{force}$
$ \vec{F}_f  \leq \mu  \vec{F}_N $	$K = \text{kinetic energy}$	$\Delta V = \frac{Q}{C}$	$I = \text{current}$
$\Delta E = W = \int \vec{F} \cdot d\vec{r}$	$k = \text{spring constant}$	$C = \frac{\kappa\epsilon_0 A}{d}$	$J = \text{current density}$
$K = \frac{1}{2} mv^2$	$\ell = \text{length}$	$C_p = \sum_i C_i$	$L = \text{inductance}$
$P = \frac{dE}{dt}$	$L = \text{angular momentum}$	$\frac{1}{C_s} = \sum_i \frac{1}{C_i}$	$\ell = \text{length}$
$P = \vec{F} \cdot \vec{v}$	$m = \text{mass}$	$I = \frac{dQ}{dt}$	$n = \text{number of loops of wire per unit length}$
$\Delta U_g = mg\Delta h$	$P = \text{power}$	$U_C = \frac{1}{2} Q\Delta V = \frac{1}{2} C(\Delta V)^2$	$N = \text{number of charge carriers per unit volume}$
$a_c = \frac{v^2}{r} = \omega^2 r$	$p = \text{momentum}$	$R = \frac{\rho \ell}{A}$	$P = \text{power}$
$\vec{\tau} = \vec{r} \times \vec{F}$	$r = \text{radius or distance}$	$\vec{E} = \rho \vec{J}$	$Q = \text{charge}$
$\vec{\alpha} = \frac{\Sigma \vec{\tau}}{I} = \frac{\vec{\tau}_{net}}{I}$	$U = \text{potential energy}$	$I = Nev_d A$	$q = \text{point charge}$
$I = \int r^2 dm = \Sigma mr^2$	$v = \text{velocity or speed}$	$I = \frac{\Delta V}{R}$	$R = \text{resistance}$
$x_{cm} = \frac{\Sigma m_i x_i}{\Sigma m_i}$	$W = \text{work done on a system}$	$R_s = \sum_i R_i$	$r = \text{radius or distance}$
$v = r\omega$	$x = \text{position}$	$\frac{1}{R_p} = \sum_i \frac{1}{R_i}$	$t = \text{time}$
$\vec{L} = \vec{r} \times \vec{p} = I\vec{\omega}$	$\mu = \text{coefficient of friction}$	$P = I\Delta V$	$U = \text{potential or stored energy}$
$K = \frac{1}{2} I\omega^2$	$\theta = \text{angle}$		$V = \text{electric potential}$
$\omega = \omega_0 + \alpha t$	$\tau = \text{torque}$		$v = \text{velocity or speed}$
$\theta = \theta_0 + \omega_0 t + \frac{1}{2} \alpha t^2$	$\omega = \text{angular speed}$		$\rho = \text{resistivity}$
	$\alpha = \text{angular acceleration}$		$\Phi = \text{flux}$
	$\phi = \text{phase angle}$		$\kappa = \text{dielectric constant}$
	$\vec{F}_s = -k\Delta \vec{x}$		$\vec{F}_M = q\vec{v} \times \vec{B}$
	$U_s = \frac{1}{2} k(\Delta x)^2$		$\oint \vec{B} \cdot d\vec{\ell} = \mu_0 I$
	$x = x_{\max} \cos(\omega t + \phi)$		$d\vec{B} = \frac{\mu_0}{4\pi} \frac{Id\vec{\ell} \times \vec{r}}{r^2}$
	$T = \frac{2\pi}{\omega} = \frac{1}{f}$		$\vec{F} = \int Id\vec{\ell} \times \vec{B}$
	$T_s = 2\pi \sqrt{\frac{m}{k}}$		$B_s = \mu_0 nI$
	$T_p = 2\pi \sqrt{\frac{\ell}{g}}$		$\Phi_B = \int \vec{B} \cdot d\vec{A}$
	$ \vec{F}_G  = \frac{Gm_1 m_2}{r^2}$		$\epsilon = \oint \vec{E} \cdot d\vec{\ell} = -\frac{d\Phi_B}{dt}$
	$U_G = \frac{Gm_1 m_2}{r}$		$\epsilon = -L \frac{dI}{dt}$
			$U_L = \frac{1}{2} LI^2$

GO ON TO THE NEXT PAGE.

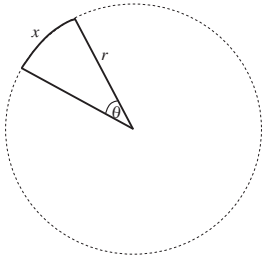
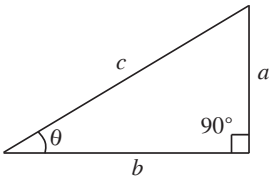
GEOMETRY AND TRIGONOMETRY		CALCULUS
<b>Rectangle</b> $A = bh$	$A$ = area $C$ = circumference $V$ = volume $S$ = surface area	$\frac{df}{dx} = \frac{df}{du} \frac{du}{dx}$
<b>Triangle</b> $A = \frac{1}{2}bh$	$b$ = base $h$ = height $\ell$ = length $w$ = width $r$ = radius $s$ = arc length $\theta$ = angle	$\frac{d}{dx}(x^n) = nx^{n-1}$
<b>Circle</b> $A = \pi r^2$ $C = 2\pi r$ $s = r\theta$		$\frac{d}{dx}(e^{ax}) = ae^{ax}$
<b>Rectangular Solid</b> $V = \ell wh$		$\frac{d}{dx}(\ln ax) = \frac{1}{x}$
<b>Cylinder</b> $V = \pi r^2 \ell$ $S = 2\pi r \ell + 2\pi r^2$		$\frac{d}{dx}[\sin(ax)] = a \cos(ax)$
<b>Sphere</b> $V = \frac{4}{3}\pi r^3$ $S = 4\pi r^2$		$\frac{d}{dx}[\cos(ax)] = -a \sin(ax)$
<b>Right Triangle</b> $a^2 + b^2 = c^2$ $\sin \theta = \frac{a}{c}$ $\cos \theta = \frac{b}{c}$ $\tan \theta = \frac{a}{b}$		$\int x^n dx = \frac{1}{n+1} x^{n+1}, n \neq -1$
		$\int e^{ax} dx = \frac{1}{a} e^{ax}$
		$\int \frac{dx}{x+a} = \ln x+a $
		$\int \cos(ax) dx = \frac{1}{a} \sin(ax)$
		$\int \sin(ax) dx = -\frac{1}{a} \cos(ax)$
		<b>VECTOR PRODUCTS</b>
		$\vec{A} \cdot \vec{B} = AB \cos \theta$
		$ \vec{A} \times \vec{B}  = AB \sin \theta$

GO ON TO THE NEXT PAGE.

PHYSICS C  
SECTION I, MECHANICS

Time—45 minutes

35 Questions

**Directions:** Each of the following questions or incomplete statements below is followed by five suggested answers or completions. Select the one that is best in each case and then mark it on your answer sheet.

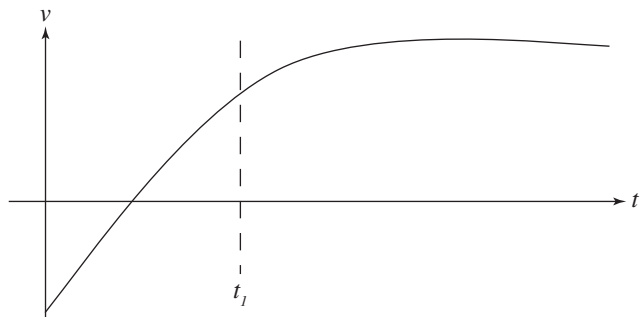

1. The graph above shows the velocity vs. time graph for a 3 kg object moving in one dimension. Which of the following is a possible graph of position-versus-time for this object?

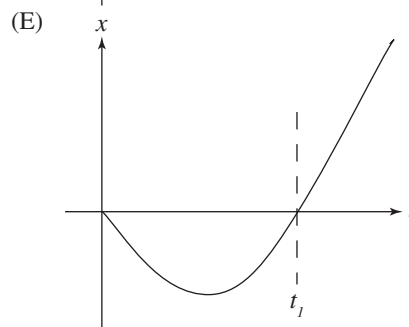
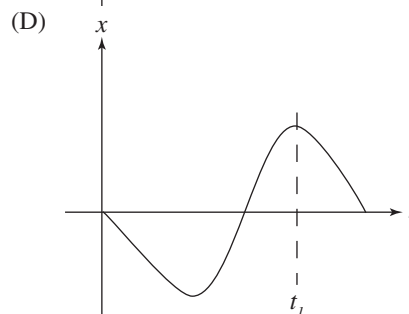
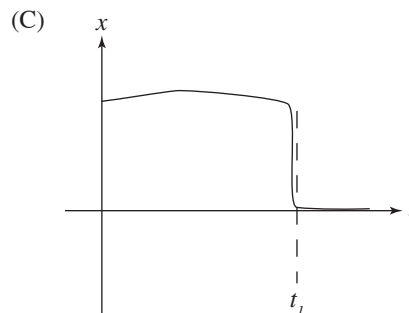
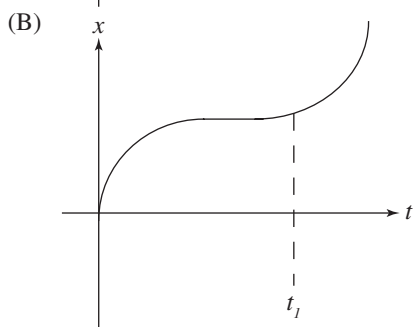
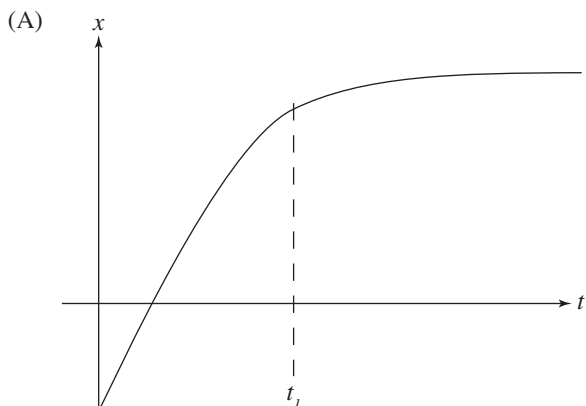

2. A ball is dropped from an 80 m tall building. How long does the ball take to reach the ground?
- (A) 2.8 seconds  
(B) 4 seconds  
(C) 8 seconds  
(D) 8.9 seconds  
(E) 16 seconds

**GO ON TO THE NEXT PAGE.**

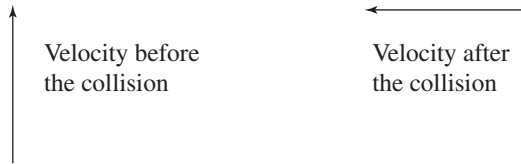

3. The velocity of an object before a collision is directed straight north and the velocity after the collision is directed straight west, as shown above. Which of the following vectors represents the change in momentum of the object?

- (A)
- (B)
- (C)
- (D)
- (E)

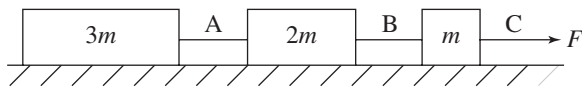

4. Three blocks of masses  $3m$ ,  $2m$ , and  $m$  are connected to strings A, B, and C as shown above. The blocks are pulled along a frictionless, horizontal floor with a force,  $F$ . Determine the acceleration of the  $2m$  block.

- (A)  $\frac{F}{2m}$
- (B)  $\frac{F}{6m}$
- (C)  $2Fm$
- (D)  $6Fm$
- (E)  $\frac{F}{m}$

## Questions 5-6

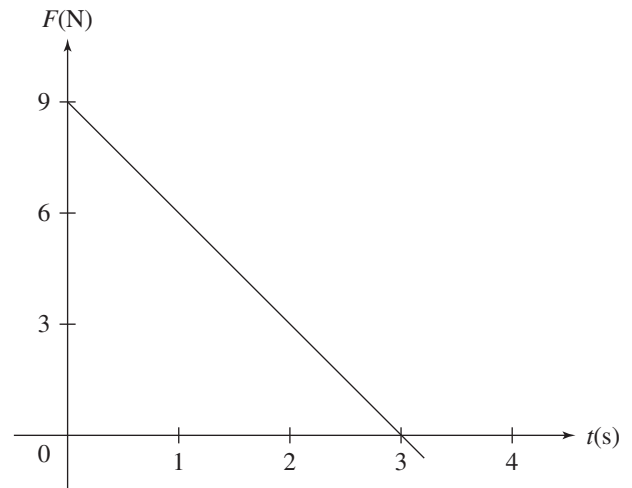

A block of mass 2 kg, initially at rest, is pulled along a frictionless, horizontal surface with a force shown as a function of time by the graph above.

5. The acceleration of the block at  $t = 2$  s is

- (A)  $0 \text{ m/s}^2$
- (B)  $1.5 \text{ m/s}^2$
- (C)  $2.0 \text{ m/s}^2$
- (D)  $2.5 \text{ m/s}^2$
- (E)  $3.0 \text{ m/s}^2$

6. The speed of the block at  $t = 3$  s is

- (A)  $0 \text{ m/s}$
- (B)  $4.5 \text{ m/s}$
- (C)  $6.75 \text{ m/s}$
- (D)  $13.5 \text{ m/s}$
- (E)  $54 \text{ m/s}$

**GO ON TO THE NEXT PAGE.**

## Questions 7-8

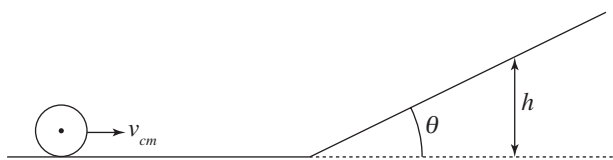

The center of mass of a cylinder of mass  $m$ , radius  $r$ , and rotational inertia  $I = \frac{1}{2}mr^2$  has a velocity of  $v_{cm}$  as it rolls without slipping along a horizontal surface. It then encounters a ramp of angle  $\theta$ , and continues to roll up the ramp without slipping.

7. What is the maximum height the cylinder reaches?

- (A)  $\frac{v^2}{4g}$   
 (B)  $\frac{4v^2}{3g}$   
 (C)  $\frac{v^2}{3g}$   
 (D)  $\frac{3v^2}{4g}$   
 (E)  $\frac{4g}{3v^2}$

8. Now the cylinder is replaced with a hoop that has the same mass and radius. The hoop's rotational inertia is  $mr^2$ . The center of mass of the hoop has the same velocity as the cylinder when it is rolling along the horizontal surface and the hoop also rolls up the ramp without slipping. How would the maximum height of the hoop compare to the maximum height of the cylinder?

- (A) The hoop would reach a greater maximum height than the cylinder.  
 (B) The hoop and cylinder would reach the same maximum height.  
 (C) The cylinder would reach a greater maximum height than the hoop.  
 (D) The cylinder would reach less than half the height of the hoop.  
 (E) None of the above

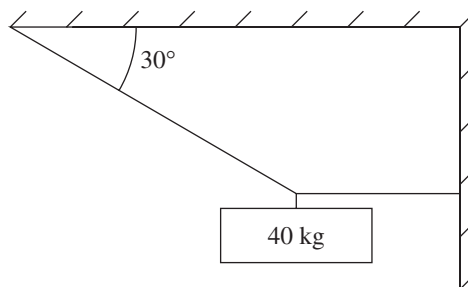

9. An object of mass 40 kg is suspended by means of two cords, as shown above. The tension in the angled cord is

- (A) 80 N  
 (B) 230 N  
 (C) 400 N  
 (D) 690 N  
 (E) 800 N

GO ON TO THE NEXT PAGE.



## Questions 10-12

A box is on an incline of angle  $\theta$  above the horizontal. The box may be subject to the following forces: frictional ( $f$ ), gravitational ( $F_g$ ), tension from a string connected to it ( $F_T$ ), and normal ( $N$ ). In the following free-body diagrams for the box, the lengths of the vectors are proportional to the magnitudes of the forces.

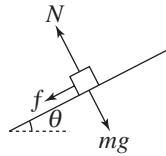

Figure A

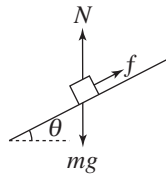

Figure B

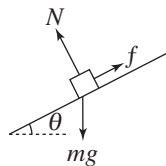

Figure C

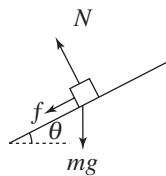

Figure D

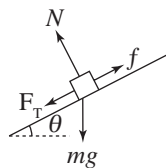

Figure E

10. Which of the following best represents the free-body diagram for the box if it is decelerating as it goes up the incline?
- (A) Figure A  
(B) Figure B  
(C) Figure C  
(D) Figure D  
(E) Figure E

11. Which of the following best represents the free-body diagram for the box if it is moving at a constant velocity down the ramp?
- (A) Figure A  
(B) Figure B  
(C) Figure C  
(D) Figure D  
(E) Figure E

12. Which of the following best represents the free-body diagram for the box if its speed is increasing as it moves down the incline?
- (A) Figure A  
(B) Figure B  
(C) Figure C  
(D) Figure D  
(E) Figure E



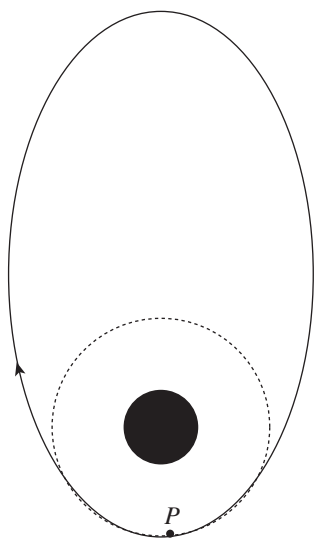

13. The force on an object as a function of time  $t$  is given by the expression  $F = Ct^3$ , where  $C$  is a constant. Determine the change in momentum for the time interval 0 to  $t_1$ .

- (A)  $\frac{Ct_1^2}{2}$   
(B)  $\frac{Ct_1^3}{3}$   
(C)  $\frac{Ct_1^4}{3}$   
(D)  $\frac{Ct_1^3}{4}$   
(E)  $\frac{Ct_1^4}{4}$

**GO ON TO THE NEXT PAGE.**

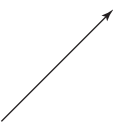

14. A spaceship orbits Earth in a clockwise, elliptical orbit as shown above. The spaceship needs to change to a circular orbit. When the spaceship passes point  $P$ , a short burst of the ship's engine will change its orbit. What direction should the engine burst be directed?

- (A) 
- (B) 
- (C) 
- (D) 
- (E) 

15. A motorcycle of mass 200 kg completes a vertical, circular loop of radius 5 m, with a constant speed of 10 m/s. How much work is done on the motorcycle by the normal force of the track?
- (A) 0 J  
 (B)  $1 \times 10^5$  J  
 (C)  $1 \times 10^6$  J  
 (D) 4 J  
 (E)  $10\pi$  J

16. A ball with a radius of 0.2 m rolls without slipping on a level surface. The center of mass of the ball moves at a constant velocity, moving a distance of 30 meters in 10 seconds. The angular speed of the ball about its point of contact on the surface is

- (A) 0.6 rad/s  
 (B) 3 rad/s  
 (C) 8 rad/s  
 (D) 15 rad/s  
 (E) 60 rad/s

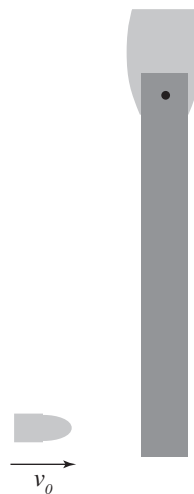

17. A bullet is moving with a velocity  $v_0$  when it collides with and becomes embedded in a wooden bar that is hinged at one end, as shown above. Consider the bullet and the wooden bar to be the system. For this scenario, which of the following is true?
- (A) The linear momentum of the system is conserved because the net force on the system is zero.  
 (B) The angular momentum of the system is conserved because the net torque on the system is zero.  
 (C) The kinetic energy of the system is conserved because it is an inelastic collision.  
 (D) The kinetic energy of the system is conserved because it is an elastic collision.  
 (E) Linear momentum and angular momentum are both conserved.

**GO ON TO THE NEXT PAGE.**

## Questions 18-19

A spring mass system is vibrating along a frictionless, horizontal floor. The spring constant is 8 N/m, the amplitude is 5 cm, and the period is 4 seconds.

18. In kg, the mass of the system is

(A)  $32\pi^2$

(B)  $\frac{32}{\pi^2}$

(C)  $\frac{16}{\pi}$

(D)  $\frac{0.2}{\pi^2}$

(E)  $\frac{20}{\pi^2}$

19. Which of the following equations could represent the position of the mass from equilibrium  $x$  as a function of time  $t$ , where  $x$  is in meters and  $t$  is in seconds.

(A)  $x = 0.05 \cos \pi t$

(B)  $x = 0.05 \cos 2\pi t$

(C)  $x = 0.05 \cos \frac{\pi}{2} t$

(D)  $x = 8 \cos \frac{\pi}{2} t$

(E)  $x = 0.05 \cos \frac{\pi}{4} t$

20. Two blocks of masses  $M$  and  $3M$  are connected by a light string. The string passes over a frictionless pulley of negligible mass so that the blocks hang vertically. The blocks are then released from rest. What is the acceleration of the mass  $M$ ?

(A)  $\frac{g}{4}$

(B)  $\frac{g}{3}$

(C)  $g$

(D)  $\frac{2g}{3}$

(E)  $\frac{g}{2}$

21. For a particular nonlinear spring, the relationship between the magnitude of the applied force,  $F$ , and the stretch of the spring,  $x$ , is given by the equation  $F = kx^{1.5}$ . How much energy is stored in the spring when it is stretched a distance  $x_1$ ?

(A)  $\frac{2kx_1^{2.5}}{5}$

(B)  $\frac{kx_1^{1.5}}{5}$

(C)  $kx_1^{2.5}$

(D)  $\frac{1}{2}kx_1^2$

(E)  $1.5kx_1^{.5}$

**GO ON TO THE NEXT PAGE.**

## Questions 22-23

Two ice skaters are moving on frictionless ice and are about to collide. The 50-kg skater is moving directly west at 4 m/s. The 75-kg skater is moving directly north at 2 m/s. After the collision they stick together.

22. What is the magnitude of the momentum of the two-skater system after the collision?
- (A) 50 kg•m/s  
 (B) 150 kg•m/s  
 (C) 200 kg•m/s  
 (D) 250 kg•m/s  
 (E) 350 kg•m/s
23. For this scenario, which of the following is true?
- (A) The linear momentum of the system is conserved because the net force on the system is nonzero during the collision.  
 (B) Only the kinetic energy of the system is conserved because it is an inelastic collision.  
 (C) Only the kinetic energy of the system is conserved because it is an elastic collision.  
 (D) The linear momentum of the system is conserved because the net force on the system is zero.  
 (E) Both the linear momentum and the kinetic energy of the system are conserved.

24. The position of an object is given by the equation  $x = 2.0t^3 + 4.0t + 6.25$ , where  $x$  is in meters and  $t$  is in seconds. What is the acceleration of the object at  $t = 1.50$  s?

- (A) 6 m/s<sup>2</sup>  
 (B) 12 m/s<sup>2</sup>  
 (C) 18 m/s<sup>2</sup>  
 (D) 24 m/s<sup>2</sup>  
 (E) 32 m/s<sup>2</sup>

25. An astronaut in space accidentally becomes disconnected from her ship's tether. In order to get back to safety, she throws a wrench of mass  $m = 2$  kg directly away from the ship at a speed  $v = 30$  m/s. Given that she has a mass of 60 kg and was at rest before throwing the wrench, how long will it take her to get back to the ship if she is 35 m away from it?

- (A) 60 s  
 (B) 45 s  
 (C) 35 s  
 (D) 25 s  
 (E) 15 s

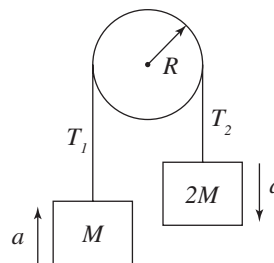

26. Two blocks of masses  $M$  and  $2M$  are connected by a light string. The string passes over a pulley, as shown above. The pulley has a radius  $R$  and moment of inertia  $I$  about its center.  $T_1$  and  $T_2$  are the tensions in the string on each side of the pulley and  $a$  is the acceleration of the masses. Which of the following equations best describes the pulley's rotational motion during the time the blocks accelerate?

- (A)  $(T_2 + T_1)R = Ia$   
 (B)  $(T_2 - T_1)R = Ia$   
 (C)  $(T_2 - T_1)R = I \frac{a}{R}$   
 (D)  $MgR = I \frac{a}{R}$   
 (E)  $3MgR = I \frac{a}{R}$

GO ON TO THE NEXT PAGE.

27. A solid sphere of uniform density with mass  $M$  and radius  $R$  is located far out in space. A test mass,  $m$ , is placed at various locations both within the sphere and outside the sphere. Which graph correctly shows the force of gravity on the test mass vs. the distance from the center of the sphere?

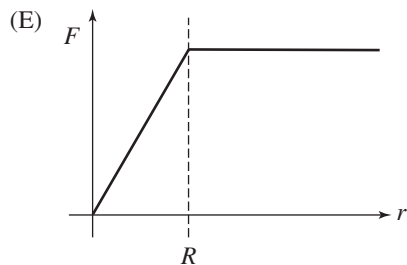
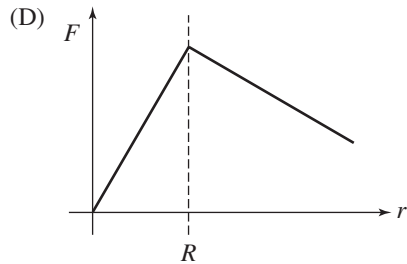
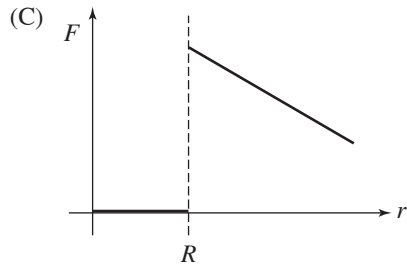
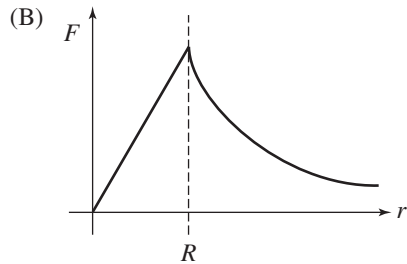
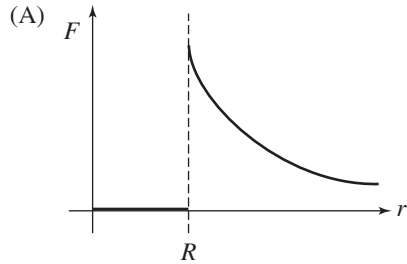

28. The Gravitron is a carnival ride that looks like a large cylinder. People stand inside the cylinder against the wall as it begins to spin. Eventually, it is rotating fast enough that the floor can be removed without anyone falling. Given then the coefficient of friction between a person's clothing and the wall is  $\mu$ , the tangential speed is  $v$ , and the radius of the ride is  $r$ , what is greatest mass that a person can be to safely go on this ride?

- (A)  $\mu v^2/(rg)$   
 (B)  $\mu v^2/(r^2g)$   
 (C)  $r^2v^2/(\mu g)$   
 (D)  $rg/(\mu v^2)$   
 (E) None of the above

29. A simple pendulum of length  $L$ , mass  $m$ , and amplitude  $A$  has a frequency of  $f$  on Earth. If this pendulum were moved to the Moon (which has  $\frac{1}{6}$  Earth's gravity), what would be its new frequency?

- (A)  $\left(\frac{1}{6}\right)^2 f$   
 (B)  $\left(\frac{1}{6}\right)^{\frac{1}{2}} f$   
 (C)  $(6^2)f$   
 (D)  $(6)^{\frac{1}{2}} f$   
 (E)  $f$

30. An electric car of mass 300 kg delivers 400 W as it moves the car at a constant 20 m/s. The force delivered by the motor is

- (A)  $\frac{4}{3}$  N  
 (B) 20 N  
 (C) 600 N  
 (D) 6,000 N  
 (E) 8,000 N

GO ON TO THE NEXT PAGE.

31. A 2.0 kg mass is attached to the end of a vertical ideal spring with a spring constant of 800 N/m. The mass is pulled down 10 cm from the equilibrium position and then released, so that it oscillates. The kinetic energy of the 2.0 kg mass at the equilibrium position is

(A)  $\frac{2}{3}$  J  
 (B) 2 J  
 (C) 4 J  
 (D) 12 J  
 (E) 40 J

32. Physics students are checking the constant acceleration equations of kinematics by measuring the velocity of a tennis ball that is dropped and falls 6 meters and then passes through a photogate. The predicted velocity is 20% above the velocity measured by the photogate. Which of the following best describes the cause of the large percent difference?
- (A) The ball changes its shape while falling.  
 (B) The acceleration of gravity varies as the ball is falling.  
 (C) Air resistance increases the acceleration of the ball.  
 (D) The acceleration of the balls varies with the velocity.  
 (E) The acceleration of gravity changes due to air resistance.

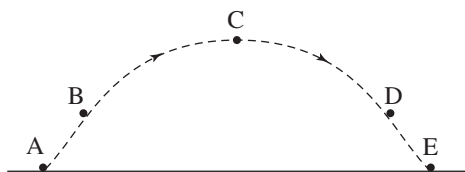

33. An object is launched and follows the dashed path shown above. If air resistance is considered, when is the velocity of the object the greatest and the acceleration of the object the greatest?

<u>Greatest Velocity</u>	<u>Greatest Acceleration</u>
(A) A	All equal to $g$
(B) C	All equal to $g$
(C) A	A
(D) E	E
(E) A	E

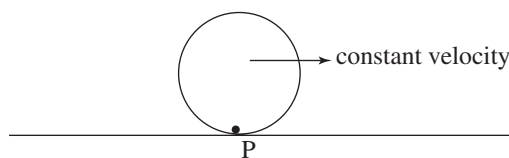

34. A disk is rolling without slipping along the ground and the center of mass is traveling at a constant velocity, as shown above. What direction is the acceleration of the contact point P and the center of mass?

<u>Acceleration of Contact Point P</u>	<u>Acceleration of Center of Mass</u>
(A) Upward	To the right
(B) Upward	Zero
(C) To the right	Zero
(D) To the right	To the right
(E) Upward and to the right	Zero

35. The escape velocity for a rocket launched from the surface of a planet is  $v_0$ . Determine the escape velocity for another planet that has twice the mass and twice the radius of this planet.

(A)  $2v_0$   
 (B)  $\frac{1}{2}v_0$   
 (C)  $\frac{1}{\sqrt{2}}v_0$   
 (D)  $\sqrt{2}v_0$   
 (E)  $v_0$

STOP

END OF SECTION I, MECHANICS

PHYSICS C  
SECTION II, MECHANICS

Time—45 minutes

3 Questions

**Directions:** Answer all three questions. The suggested time is about 15 minutes per question for answering each of the questions, which are worth 15 points each. The parts within a question may not have equal weight.

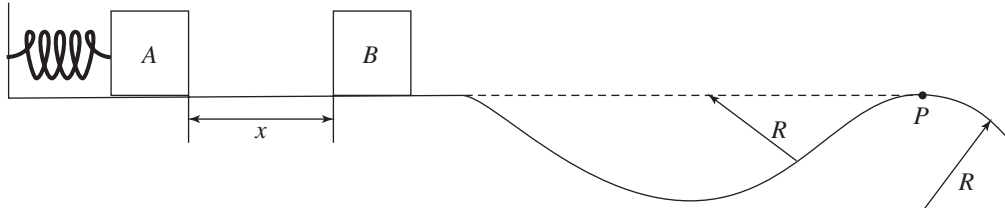

- A massless spring with force constant  $k$  is attached at its left end to a wall, as shown above. Initially, block  $A$  and block  $B$ , each of mass  $M$ , are at rest on a frictionless, level surface, with block  $A$  in contact with the spring (but not compressing it) and block  $B$  a distance  $x$  from block  $A$ . Block  $A$  is then moved to the left, compressing the spring a distance of  $d$ , and held in place while block  $B$  remains at rest. First block  $A$  is released, then as it passes the equilibrium position loses contact with the spring. After block  $A$  is released it moves forward and has a perfectly inelastic collision with block  $B$  and then follows the frictionless, curved path shown above. The radius of the valley and the hill in the diagram are both  $R$ . Answer the following in terms of  $M$ ,  $k$ ,  $d$ ,  $x$ ,  $g$ , and  $R$ .

  - Determine the speed of block  $A$  just before it collides with block  $B$ .
  - Determine the speed of block  $B$  just after the collision occurs.
  - Determine the change in kinetic energy for the collision.
  - Determine the normal force on the boxes when they are at position  $P$ , the top of the hill.

**GO ON TO THE NEXT PAGE.**

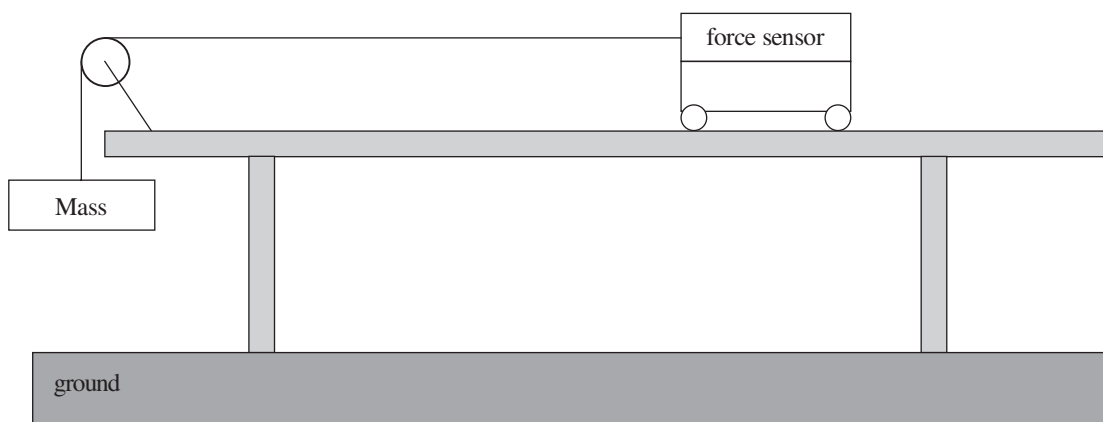

2. Physics students are performing a lab using the mass-pulley system shown above. The cart has a force sensor attached to it, and the total mass of the force sensor and cart is 1.2 kg. The force sensor is attached to a 300-gram hanging mass by a string that is placed over a pulley. When the system is released, a motion detector recording the motion of the cart produces the following velocity versus time graph.

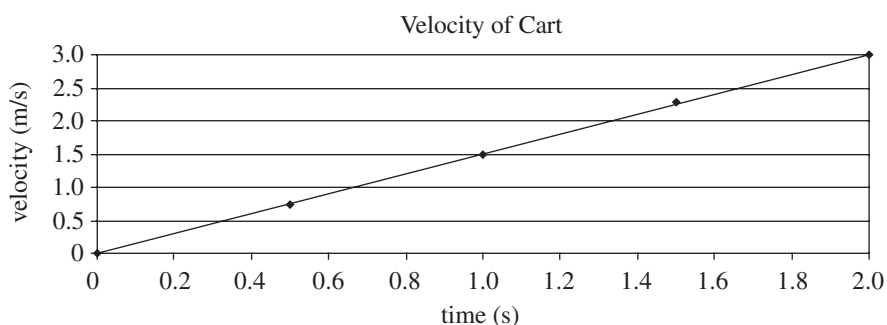

- Calculate the acceleration of the cart.
- Assume tension is the only horizontal force on the force sensor/cart combination (ignore friction). Calculate the tension in the string for this scenario.
- The measured tension is actually 20% greater than the tension predicted in (b). Explain why this might be the case. The force sensor and the motion sensor are working properly, so do not use faulty data to explain the result.
- Describe a process you could use to determine the rotational inertia of the pulley with this system, a meterstick, the force sensor, and motion sensor.

**GO ON TO THE NEXT PAGE.**



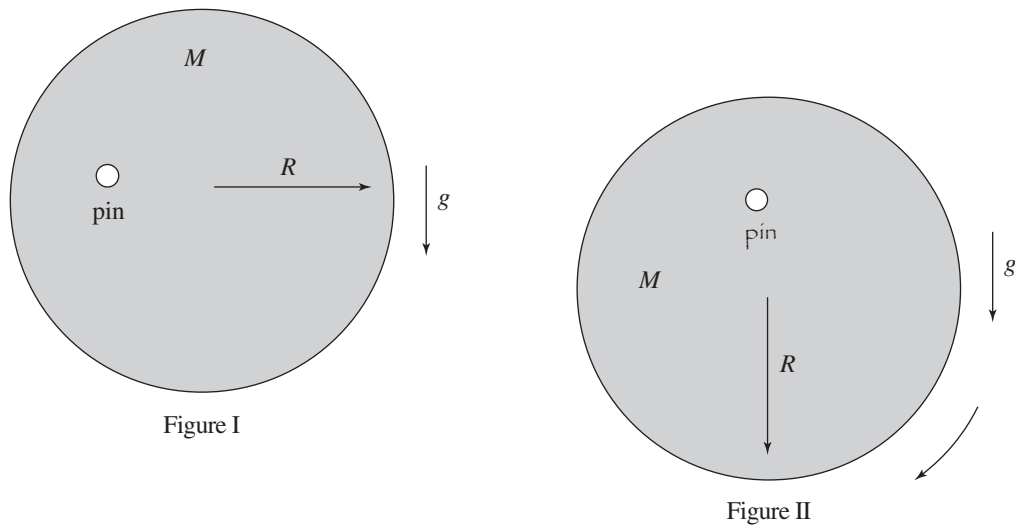

3. A disk of mass  $M$  and radius  $R$  is pinned half of the way along its radius, and held in a horizontal position, as shown in Figure I. The rotational inertia of the disk about its center is  $\frac{1}{2}MR^2$ . The disk is released at  $t = 0$  s, and falls to the vertical position shown in Figure II, and it continues to rotate about the pin. Answer the following in terms of  $M$ ,  $R$ , and  $g$ .
- Calculate the rotational inertia of the disk about the pin.
  - Calculate the angular acceleration of the disk at  $t = 0$  s.
  - Calculate angular velocity of the disk when it is in the vertical position shown in Figure II.

Now the disk is stopped and brought to rest in the vertical position shown in Figure II. It is given a slight disturbance to an angle  $\theta_0$ .

- Calculate the angular frequency of the oscillation.

**STOP**

END OF SECTION II, MECHANICS

PHYSICS C  
SECTION I, ELECTRICITY AND MAGNETISM

Time—45 minutes

35 Questions

**Directions:** Each of the following questions or incomplete statements below is followed by five suggested answers or completions. Select the one that is best in each case and then mark it on your answer sheet.

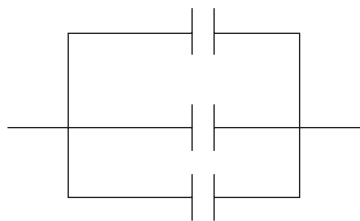

36. Three  $3\ \mu\text{F}$  capacitors are connected in parallel as shown above. Determine the equivalent capacitance of the arrangement.

(A)  $\frac{1}{3}\ \mu\text{F}$   
 (B)  $1\ \mu\text{F}$   
 (C)  $3\ \mu\text{F}$   
 (D)  $6\ \mu\text{F}$   
 (E)  $9\ \mu\text{F}$

37. A particular microwave requires some power,  $P$ , to operate. In America, a typical outlet provides electricity at 120 V. This would send a current,  $I$ , to the microwave. If this same microwave were taken to Europe, where the outlets provide twice the voltage, what would be the new current?

(A)  $\frac{1}{4}I$   
 (B)  $\frac{1}{2}I$   
 (C)  $I$   
 (D)  $2I$   
 (E)  $4I$

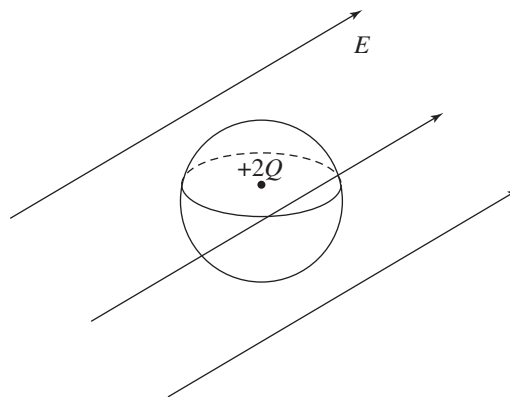

38. A uniform electric field exists in a region, and then a neutral, conducting, spherical shell with a stationary charge  $+2Q$  at its center is placed in the region, as shown above. The radius of the sphere is  $R$ . The flux through the sphere depends on the value of

(A)  $E$ ,  $Q$ , and  $R$   
 (B) Only  $R$   
 (C)  $E$  and  $Q$   
 (D)  $R$  and  $Q$   
 (E) Only  $Q$

39. In a certain region, the electric field varies with the radius away from origin by the equation  $E_r = -6r^2 + 4r + 3$ , where  $r$  is given in meters and  $E$  in  $\text{N/C}$ . The potential difference between the origin and the point (3, 4) is

(A)  $-165\ \text{V}$   
 (B)  $-120\ \text{V}$   
 (C)  $64\ \text{V}$   
 (D)  $185\ \text{V}$   
 (E)  $315\ \text{V}$

**GO ON TO THE NEXT PAGE.**

## Questions 40-41

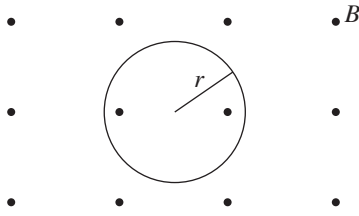

A particle of charge  $-q$  and mass  $m$  moves with speed  $v$  perpendicular to a uniform magnetic field  $B$  directed out of the page. The path of the particle is a circle of radius  $r$ , as shown above.

40. Which of the following correctly gives the direction of motion and the magnitude of the acceleration of the charge?

<u>Direction</u>	<u>Acceleration of Charge</u>
(A) Clockwise	$qBv$
(B) Clockwise	$\frac{qBv}{m}$
(C) Counterclockwise	$\frac{qBv}{m}$
(D) Counterclockwise	$qBv$
(E) Counterclockwise	$\frac{qBv}{r}$

41. The frequency with which the particle completes the circular path is

- (A)  $\frac{v}{2r}$   
 (B)  $\frac{mv}{2\pi r}$   
 (C)  $\frac{2\pi r}{v}$   
 (D)  $\frac{v}{2\pi r}$   
 (E)  $\frac{v}{2\pi}$

42. A  $30 \mu\text{F}$  capacitor has 6 millicoulombs of charge on each plate. The energy stored in the capacitor is most nearly

- (A)  $5.4 \times 10^{-10} \text{ J}$   
 (B)  $9.0 \times 10^{-8} \text{ J}$   
 (C)  $0.6 \text{ J}$   
 (D)  $12.5 \text{ J}$   
 (E)  $100 \text{ J}$

43. Two large, parallel conducting plates have a potential difference of  $V$  maintained across them. A proton starts at rest on the surface of one plate and accelerates toward the other plate. Its acceleration in the region between the plates is proportional to

- (A)  $\frac{1}{V}$   
 (B)  $\frac{1}{\sqrt{V}}$   
 (C)  $\sqrt{V}$   
 (D)  $V$   
 (E)  $V^2$

GO ON TO THE NEXT PAGE.

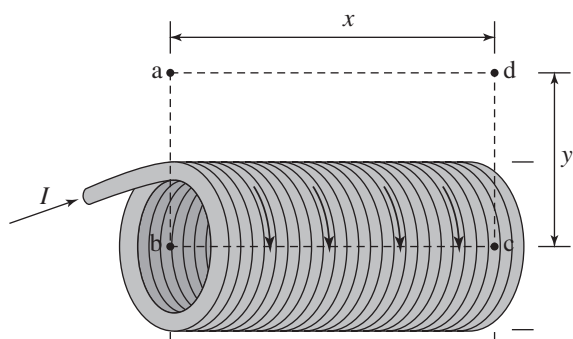

44. An ideal solenoid with  $N$  total turns has a current  $I$  passing through the helical wires that make up the solenoid. Ampere's law is used with a rectangular path  $abcd$  as shown above, to calculate the magnitude of the magnetic field  $B$  within the solenoid. The horizontal distances of the path are length  $x$  and the vertical distances of the path are length  $y$ . Which of the following equations results from the correct application of Ampere's law in this situation?

- (A)  $B(2x + 2y) = \mu_0 NI$   
 (B)  $B(2x) = \mu_0 NI$   
 (C)  $B(x + 2y) = \mu_0 NI$   
 (D)  $B(2y) = \mu_0 NI$   
 (E)  $B(x) = \mu_0 NI$

## Questions 45-46

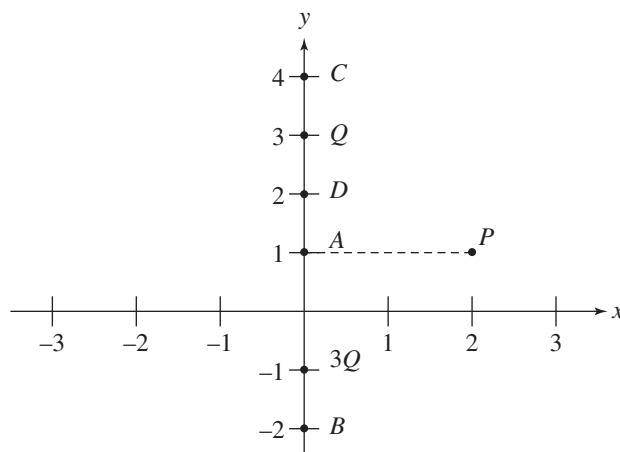

Particles of charge  $+3Q$  and  $+Q$  are located on the  $y$ -axis as shown above. Assume the particles are isolated from other particles and are stationary.  $A$ ,  $B$ ,  $C$ ,  $D$ , and  $P$  are points in the plane as indicated in the diagram.

45. Which of the following describes the direction of the electric field at point  $P$ ?
- (A)  $+x$  direction  
 (B)  $-y$  direction  
 (C) components in both the  $+x$  and  $-y$  direction  
 (D) components in both  $-x$  and  $+y$  direction  
 (E) components in both  $+x$  and  $+y$  direction
46. At which of the labeled points is the electric potential zero?
- (A)  $A$   
 (B)  $B$   
 (C)  $C$   
 (D)  $D$   
 (E) None of the points

GO ON TO THE NEXT PAGE.

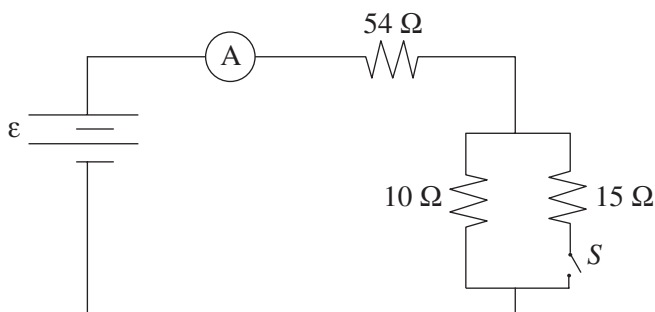

47. When the switch  $S$  is *closed* in the circuit shown above the reading on the ammeter is 3 A. When the switch is *opened* the current through the  $10\ \Omega$  resistor will

(A) double  
 (B) increase but not double  
 (C) remain the same  
 (D) decrease but not be halved  
 (E) be halved

48. Two conducting cylindrical wires are made out of the same material. Wire  $X$  has twice the length and half the radius as wire  $Y$ . What is the ratio  $\frac{R_x}{R_y}$  of their resistances?

(A) 8  
 (B) 4  
 (C) 1  
 (D)  $\frac{1}{2}$   
 (E)  $\frac{1}{4}$

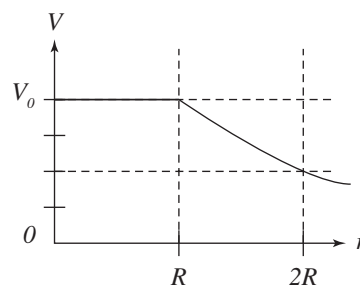

49. A graph of electric potential  $V$  as a function of the radius from the origin  $r$  is shown above. What can be concluded about the electric field in the region  $0 < r < R$ ?

(A) It increases linearly as  $r$  increases.  
 (B) It decreases linearly as  $r$  increases.  
 (C) It is zero.  
 (D) It increases non-linearly as  $r$  increases.  
 (E) It decreases non-linearly as  $r$  increases.

50. Two parallel wires, each carrying a current  $I$ , attract each other with a force  $F$ . If both currents are halved the attractive force is

(A)  $4F$   
 (B)  $\frac{1}{\sqrt{2}}F$   
 (C)  $\frac{1}{2}F$   
 (D)  $\sqrt{2}F$   
 (E)  $\frac{1}{4}F$

**GO ON TO THE NEXT PAGE.**

51. A square conducting loop of wire lies so that the plane of the loop is perpendicular to a constant magnetic field of strength  $B$ . Suppose the length of each side of the loop  $\ell$  could be increased with time  $t$  so that  $\ell = kt^2$ , where  $k$  is a positive constant. What is the magnitude of the emf induced in the loop as a function of time?

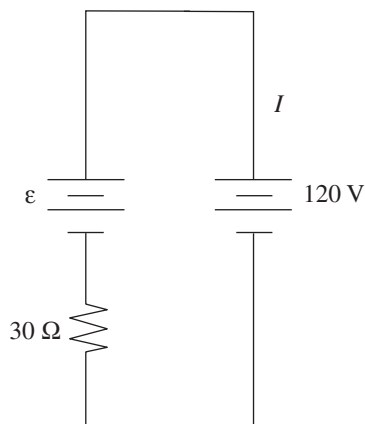

- (A)  $4Bk^2t^3$   
 (B)  $2Bk^2t$   
 (C)  $4Bkt^3$   
 (D)  $2Bkt$   
 (E)  $\frac{Bk^2t^5}{5}$

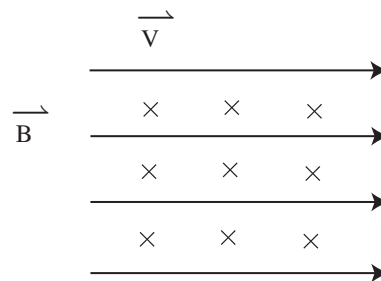

52. A battery with emf  $\varepsilon$  and internal resistance of  $30 \Omega$  is being recharged by connecting it to an outlet with a potential difference of  $120 \text{ V}$  as shown above. While it is being recharged,  $3 \text{ A}$  flows through the battery. Determine the emf of the battery.
- (A)  $210 \text{ V}$   
 (B)  $150 \text{ V}$   
 (C)  $90 \text{ V}$   
 (D)  $30 \text{ V}$   
 (E)  $9 \text{ V}$



53. A dipole molecule is traveling into the plane of the page through a uniform magnetic field directed to the right. Which of the following arrangements of the dipole would result in 0 net force, but a non-zero net torque?

- (A)   
 (B)   
 (C)   
 (D) All of the above  
 (E) None of the above

GO ON TO THE NEXT PAGE.

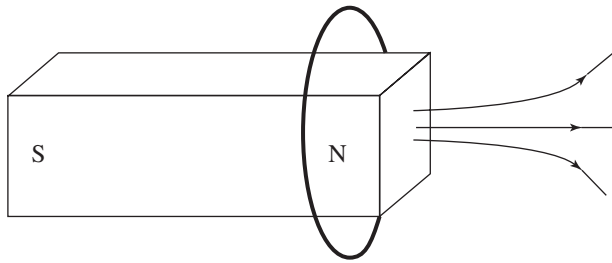

54. A conducting loop of wire is initially around a magnet as shown above. The magnet is moved to the left. What is the direction of the force on the loop and the direction of the magnetic field at the center of the loop due to the induced current?

- | Direction of Force<br>on Loop          | Direction of<br>Magnetic Field<br>at Center of Loop<br>Due to Induced Current |
|--|---|
| (A) To the right                       | To the right  |
| (B) To the right                       | To the left   |
| (C) To the left                        | To the right  |
| (D) To the left                        | To the left   |
| (E) No direction;<br>the force is zero | To the left   |

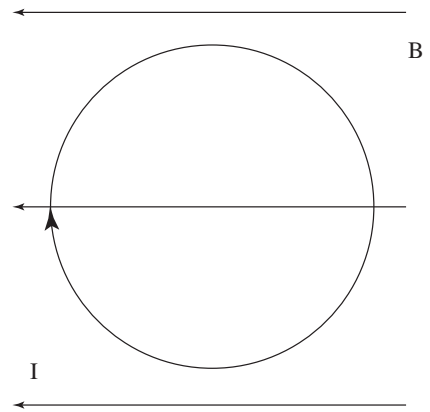

55. A loop of wire carrying a current  $I$  is initially in the plane of the page and is located in a uniform magnetic field  $B$ , which points toward the left side of the page, as shown above. Which of the following shows the correct initial rotation of the loop due to the force exerted by the magnetic field?

- (A)
- (B)
- (C)
- (D)
- (E)

**GO ON TO THE NEXT PAGE.**

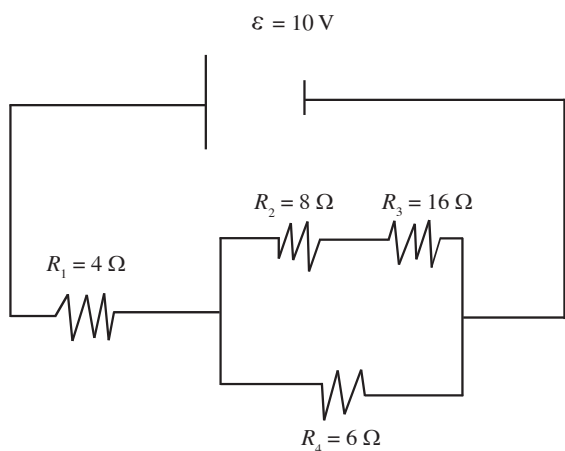

56. In the circuit above, what would be the initial current?

- (A)  $\frac{44}{5}$  A  
 (B)  $\frac{215}{62}$  A  
 (C)  $\frac{25}{22}$  A  
 (D)  $\frac{62}{215}$  A  
 (E)  $\frac{5}{44}$  A

Questions 57-58

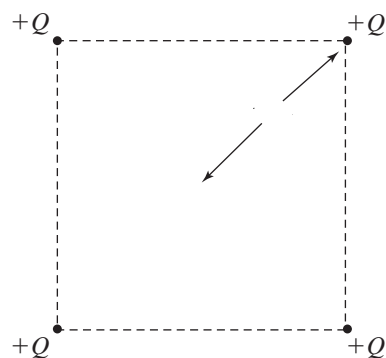

Four particles, each with a charge  $+Q$ , are held fixed at the corners of a square, as shown above. The distance from each charge to the center of the square is  $\ell$ .

57. What is the magnitude of the electric field at the center of the square?

- (A) 0  
 (B)  $\frac{4kQ}{\ell^2}$   
 (C)  $\frac{2kQ}{\ell^2}$   
 (D)  $\frac{4kQ}{\sqrt{2}\ell^2}$   
 (E)  $\frac{kQ}{\sqrt{2}\ell^2}$

58. What is the magnitude of the work required to move a charge of  $+3Q$  from the center of the square to very far away?

- (A)  $\frac{12kQ^2}{\ell}$   
 (B)  $\frac{12kQ^2}{\ell^2}$   
 (C)  $\frac{4kQ^2}{\ell^2}$   
 (D)  $\frac{3kQ^2}{\ell}$   
 (E)  $\frac{4kQ}{\ell}$





**GO ON TO THE NEXT PAGE.**

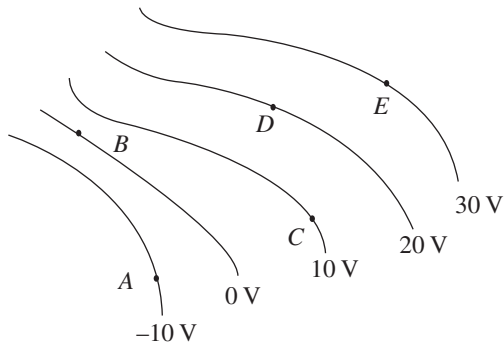

## Questions 59-61



The diagram above shows equipotential lines produced by a charge distribution. *A*, *B*, *C*, *D*, and *E* are points in the plane.

59. At which point is the magnitude of the electric field the greatest?
- (A) *A*  
 (B) *B*  
 (C) *C*  
 (D) *D*  
 (E) *E*
60. Which vector below best describes the direction of the electric field at point *D*?
- (A)   
 (B)   
 (C)   
 (D)   
 (E) 
61. A particle with a  $-3 \mu\text{C}$  charge is released from rest on the  $-10 \text{ V}$  equipotential line. What is the particle's change in electric potential energy when it reaches the  $20 \text{ V}$  equipotential line?
- (A)  $90 \mu\text{J}$   
 (B)  $60 \mu\text{J}$   
 (C)  $30 \mu\text{J}$   
 (D)  $-60 \mu\text{J}$   
 (E)  $-90 \mu\text{J}$
62. Which of Maxwell's equations allows for the calculation of a magnetic field due to a changing electric field?
- (A)  $\oint \mathbf{E} \cdot d\mathbf{A} = \frac{q}{\epsilon_0}$   
 (B)  $\oint \mathbf{E} \cdot d\boldsymbol{\ell} = \frac{d\phi_B}{dt}$   
 (C)  $\oint \mathbf{B} \cdot d\mathbf{A} = 0$   
 (D)  $\oint \mathbf{B} \cdot d\boldsymbol{\ell} = \mu_0 i + \mu_0 \epsilon_0 \frac{d\phi_E}{dt}$   
 (E) None of the above

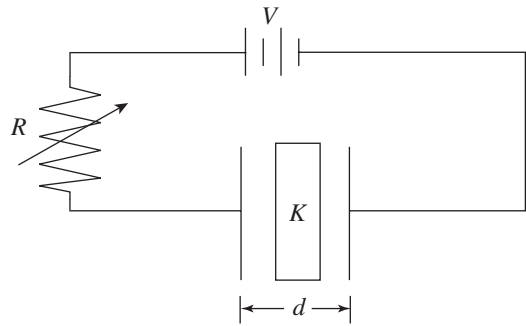

63. A parallel plate capacitor has a dielectric material between the plates with a constant  $K$ . The capacitor is connected to a variable resistor  $R$  and a power supply of potential difference  $V$ . Each plate of the capacitor has a cross-sectional area  $A$  and the plates are separated by a distance  $d$ . Which of the following changes could increase the capacitance and decrease the amount of charge stored on the capacitor?
- (A) Increase  $R$  and increase  $A$   
 (B) Decrease  $V$  and decrease  $d$   
 (C) Decrease  $R$  and increase  $d$   
 (D) Increase  $K$  and increase  $V$   
 (E) Increase  $K$  and increase  $R$

**GO ON TO THE NEXT PAGE.**

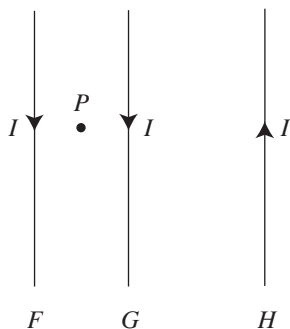

64. Three parallel wires,  $F$ ,  $G$ , and  $H$ , all carry equal current  $I$ , in the directions shown above. Wire  $G$  is closer to wire  $F$  than to wire  $H$ . The magnetic field at point  $P$  is directed
- into the page
  - out of the page
  - to the left
  - to the right
  - toward the top of the page
65. A solid, metal object is isolated from other charges and has charge distributed on its surface. The charge distribution is not uniform. It may be correctly concluded that the
- electric field outside the object is zero
  - the electric field outside the object is equal to the electric field inside the object
  - the electric field outside the object is directly proportional to the distance away from the center of mass of the object
  - the electric field outside the object, but very close to the surface, is equal to the surface charge density at any location divided by the permittivity of free space
  - the electric potential on the surface of the object is not constant

Questions 66-67 relate to the circuit represented below. The switch  $S$ , after being open a long time, is then closed.

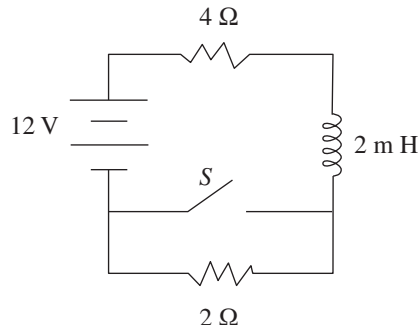

66. What is the potential difference across the inductor immediately after the switch is closed?
- 0 V
  - 2 V
  - 4 V
  - 8 V
  - 12 V
67. What is the current through the  $4\ \Omega$  resistor after the switch has been closed a long time?
- 2 A
  - 1.2 A
  - 6 A
  - 3 A
  - 1.5 A
- 
68. A spherical charge distribution varies with the radius  $r$  by the equation
- $$\rho = ar,$$
- where  $\rho$  is the volume charge density and  $a$  is a positive constant. The distribution goes out to a radius  $R$ .
- Which of the following is true of the electric field strength due to this charge distribution at a distance  $r$  from the center?
- It increases as  $r$  approaches infinity.
  - It decreases linearly for  $r > R$ .
  - It increases linearly for  $r > R$ .
  - It increases linearly for  $r < R$ .
  - It increases non-linearly for  $r < R$ .

**GO ON TO THE NEXT PAGE.**

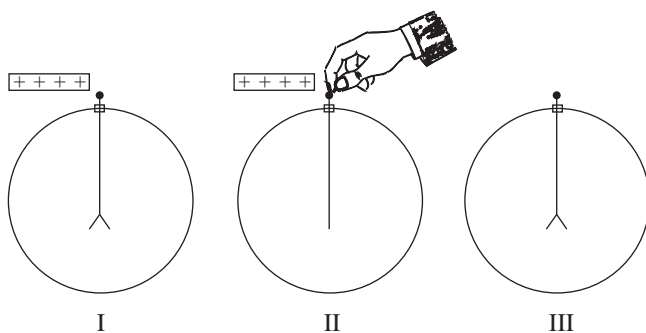

69. When a positively charged rod is brought near, but does not touch, the initially neutral electroscope shown above, the leaves repel (I). When the electroscope is then touched with a finger, the leaves hang vertically (II). Next when the finger and finally the rod are removed, the leaves repel again (III). During the process shown in Figure II

- (A) electrons are going from the electroscope into the finger
- (B) electrons are going from the finger into the electroscope
- (C) protons are going from the rod into the finger
- (D) protons are going from the finger into the rod
- (E) electrons are going from the finger into the rod

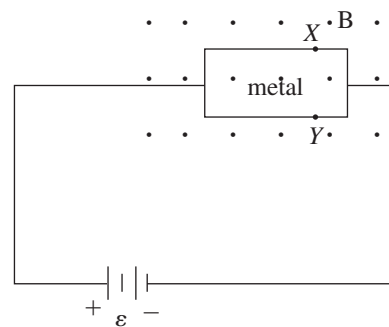

70. A piece of metal in the plane of the page is connected in a circuit as shown above, causing electrons to move through the metal to the left. The piece of metal is in a magnetic field  $B$  directed out of the page.  $X$  and  $Y$  are points on the edge of the metal. Which of the following statements is true?
- (A) The current will decrease to zero due to the magnetic field.
  - (B) The potentials at  $X$  and  $Y$  are equal.
  - (C)  $X$  is at a higher potential than  $Y$ .
  - (D)  $Y$  is at a higher potential than  $X$ .
  - (E) The current will increase exponentially due to the magnetic field.

STOP

END OF SECTION I, ELECTRICITY AND MAGNETISM

PHYSICS C  
SECTION II, ELECTRICITY AND MAGNETISM

Time—45 minutes

3 Questions

Directions: Answer all three questions. The suggested time is about 15 minutes per question for answering each of the questions, which are worth 15 points each. The parts within a question may not have equal weight.

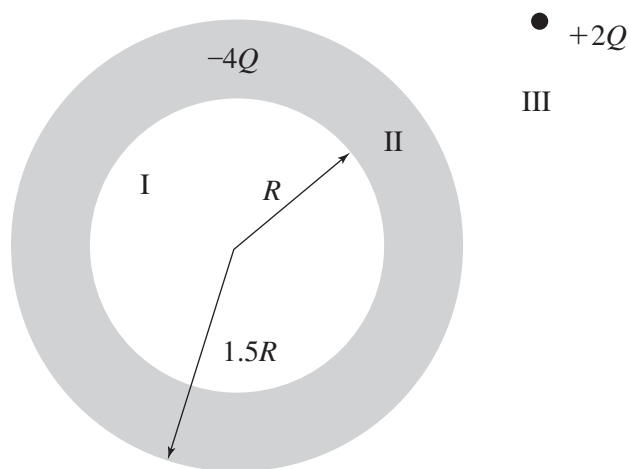

1. A spherical, metal shell of inner radius  $R$  and outer radius  $1.5R$  has a charge of  $-4Q$ . A point charge of  $+2Q$  is initially located outside the shell as shown above. Express all answers in terms of fundamental constants and given values.
- (a) (i) Determine the charge on each surface of the spherical shell.  
(ii) Sketch the electric field in regions I, II, and III.

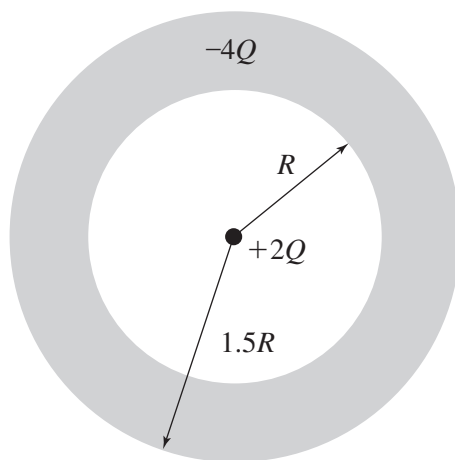

GO ON TO THE NEXT PAGE.

Now the  $+2Q$  point charge is moved to the center of the spherical shell as shown above.

- (b) Determine the electric field strength for the following radii.
  - (i)  $r < R$
  - (ii)  $R < r < 1.5R$
  - (iii)  $r > 1.5R$
- (c) Determine the potential difference between infinity and the outside surface of the spherical shell.

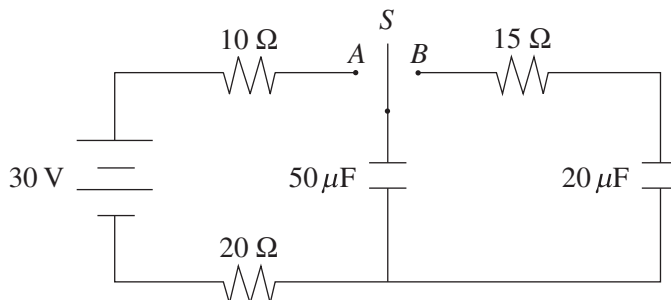

2. In the circuit shown above, the switch  $S$  is initially in the open position and both capacitors are initially uncharged. Then the switch is moved to position  $A$ .
- (a) Determine the current through the  $20\ \Omega$  resistor immediately after the switch is moved to position  $A$ .
  - (b) Sketch a graph of voltage vs. time for the voltage across the  $10\ \Omega$  resistor.

After a long time the switch is moved to position  $B$ .

- (c) Determine the current through the  $15\ \Omega$  resistor immediately after the switch is moved to position  $B$ .
- (d) Determine the amount of charge stored on the upper plate of the  $20\ \mu\text{F}$  capacitor after a long time.

**GO ON TO THE NEXT PAGE.**

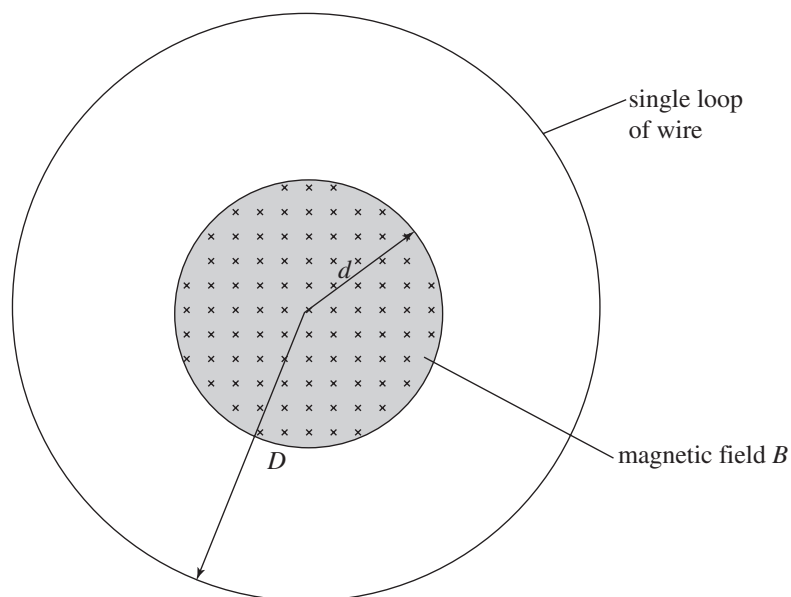

3. A uniform magnetic field  $B$  is directed into the page, and exists in a circular region of radius  $d$ . A single loop of wire of radius  $D$  is placed concentrically around the magnetic field region in the plane of the page. The initial magnetic field strength is  $B_0$ . Calculate the following in terms of given values and fundamental constants.

(a) Determine the initial flux through the loop of wire.

At time  $t = 0$  s, the magnetic field strength as a function of time  $t$  is given by the equation  $B(t) = B_0 t^2$ , where  $B_0$  is a positive constant.

- (b) Determine the magnitude of the induced emf in the single loop.  
 (c) Determine the direction of the induced current in the loop.

The loop of wire has a resistance  $R$ .

(d) Determine the energy dissipated in the loop up until a given time  $t_1$ .

**STOP**

**END OF EXAM**

---

Completely darken bubbles with a No. 2 pencil. If you make a mistake, be sure to erase mark completely. Erase all stray marks.

1. YOUR NAME: \_\_\_\_\_  
(Print) Last First M.I.

SIGNATURE: \_\_\_\_\_ DATE: \_\_\_\_/\_\_\_\_/\_\_\_\_

HOME ADDRESS: \_\_\_\_\_  
(Print) Number and Street

\_\_\_\_\_  
City State Zip Code

PHONE NO.: \_\_\_\_\_

5. YOUR NAME

First 4 letters of last name				FIRST INIT	MID INIT
A	A	A	A	A	A
B	B	B	B	B	B
C	C	C	C	C	C
D	D	D	D	D	D
E	E	E	E	E	E
F	F	F	F	F	F
G	G	G	G	G	G
H	H	H	H	H	H
I	I	I	I	I	I
J	J	J	J	J	J
K	K	K	K	K	K
L	L	L	L	L	L
M	M	M	M	M	M
N	N	N	N	N	N
O	O	O	O	O	O
P	P	P	P	P	P
Q	Q	Q	Q	Q	Q
R	R	R	R	R	R
S	S	S	S	S	S
T	T	T	T	T	T
U	U	U	U	U	U
V	V	V	V	V	V
W	W	W	W	W	W
X	X	X	X	X	X
Y	Y	Y	Y	Y	Y
Z	Z	Z	Z	Z	Z

IMPORTANT: Please fill in these boxes exactly as shown on the back cover of your test book.

2. TEST FORM

\_\_\_\_\_

3. TEST CODE				4. REGISTRATION NUMBER						
0	A	J	0	0	0	0	0	0	0	0
1	B	K	1	1	1	1	1	1	1	1
2	C	L	2	2	2	2	2	2	2	2
3	D	M	3	3	3	3	3	3	3	3
4	E	N	4	4	4	4	4	4	4	4
5	F	O	5	5	5	5	5	5	5	5
6	G	P	6	6	6	6	6	6	6	6
7	H	Q	7	7	7	7	7	7	7	7
8	I	R	8	8	8	8	8	8	8	8
9			9	9	9	9	9	9	9	9

6. DATE OF BIRTH

Month	Day		Year	
<input type="radio"/> JAN				
<input type="radio"/> FEB	0	0	0	0
<input type="radio"/> MAR	1	1	1	1
<input type="radio"/> APR	2	2	2	2
<input type="radio"/> MAY	3	3	3	3
<input type="radio"/> JUN		4	4	4
<input type="radio"/> JUL		5	5	5
<input type="radio"/> AUG		6	6	6
<input type="radio"/> SEP		7	7	7
<input type="radio"/> OCT		8	8	8
<input type="radio"/> NOV		9	9	9
<input type="radio"/> DEC				

7. GENDER

MALE

FEMALE



1. (A) (B) (C) (D) (E)	19. (A) (B) (C) (D) (E)	37. (A) (B) (C) (D) (E)	55. (A) (B) (C) (D) (E)
2. (A) (B) (C) (D) (E)	20. (A) (B) (C) (D) (E)	38. (A) (B) (C) (D) (E)	56. (A) (B) (C) (D) (E)
3. (A) (B) (C) (D) (E)	21. (A) (B) (C) (D) (E)	39. (A) (B) (C) (D) (E)	57. (A) (B) (C) (D) (E)
4. (A) (B) (C) (D) (E)	22. (A) (B) (C) (D) (E)	40. (A) (B) (C) (D) (E)	58. (A) (B) (C) (D) (E)
5. (A) (B) (C) (D) (E)	23. (A) (B) (C) (D) (E)	41. (A) (B) (C) (D) (E)	59. (A) (B) (C) (D) (E)
6. (A) (B) (C) (D) (E)	24. (A) (B) (C) (D) (E)	42. (A) (B) (C) (D) (E)	60. (A) (B) (C) (D) (E)
7. (A) (B) (C) (D) (E)	25. (A) (B) (C) (D) (E)	43. (A) (B) (C) (D) (E)	61. (A) (B) (C) (D) (E)
8. (A) (B) (C) (D) (E)	26. (A) (B) (C) (D) (E)	44. (A) (B) (C) (D) (E)	62. (A) (B) (C) (D) (E)
9. (A) (B) (C) (D) (E)	27. (A) (B) (C) (D) (E)	45. (A) (B) (C) (D) (E)	63. (A) (B) (C) (D) (E)
10. (A) (B) (C) (D) (E)	28. (A) (B) (C) (D) (E)	46. (A) (B) (C) (D) (E)	64. (A) (B) (C) (D) (E)
11. (A) (B) (C) (D) (E)	29. (A) (B) (C) (D) (E)	47. (A) (B) (C) (D) (E)	65. (A) (B) (C) (D) (E)
12. (A) (B) (C) (D) (E)	30. (A) (B) (C) (D) (E)	48. (A) (B) (C) (D) (E)	66. (A) (B) (C) (D) (E)
13. (A) (B) (C) (D) (E)	31. (A) (B) (C) (D) (E)	49. (A) (B) (C) (D) (E)	67. (A) (B) (C) (D) (E)
14. (A) (B) (C) (D) (E)	32. (A) (B) (C) (D) (E)	50. (A) (B) (C) (D) (E)	68. (A) (B) (C) (D) (E)
15. (A) (B) (C) (D) (E)	33. (A) (B) (C) (D) (E)	51. (A) (B) (C) (D) (E)	69. (A) (B) (C) (D) (E)
16. (A) (B) (C) (D) (E)	34. (A) (B) (C) (D) (E)	52. (A) (B) (C) (D) (E)	70. (A) (B) (C) (D) (E)
17. (A) (B) (C) (D) (E)	35. (A) (B) (C) (D) (E)	53. (A) (B) (C) (D) (E)	
18. (A) (B) (C) (D) (E)	36. (A) (B) (C) (D) (E)	54. (A) (B) (C) (D) (E)	